

Article number: 54301622

Description: LDK Rod end PHS 22ECL  
Threaded left

## Measures

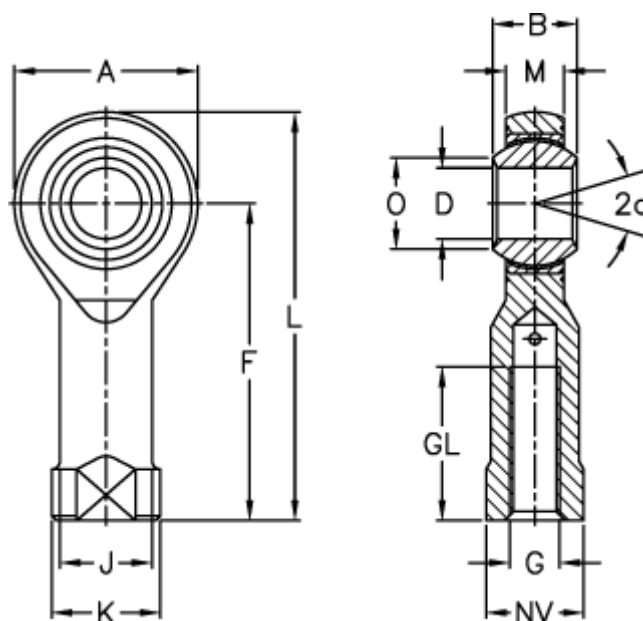

A	= 50	J	= 30.0
a (degrees)	= 15	K	= 37
B	= 28	L	= 109
D	= 22	M	= 20.00
Dynamic load C (kN)	= 34.0	NV	= 34
F	= 84	O	= 25.8
g	= M22x1,5	Static load C0 (kN)	= 71.0
GL	= 43	Weight (g)	= 490